

Trolley Systems

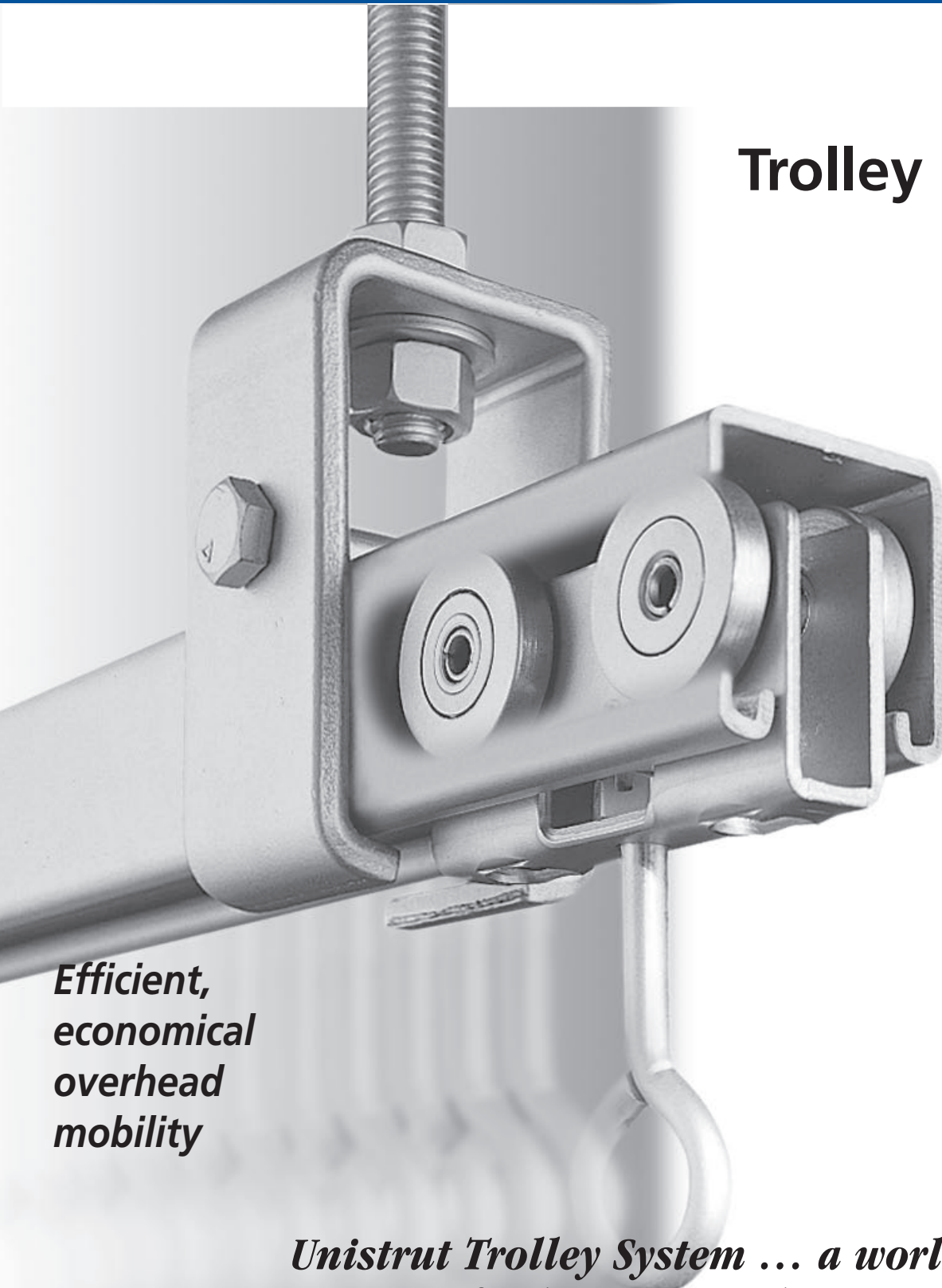

*Efficient,
economical
overhead
mobility*

*Unistrut Trolley System ... a world of
support, for keeping production on track.*

The Unistrut trolley system ... A better approach to overhead mobility...

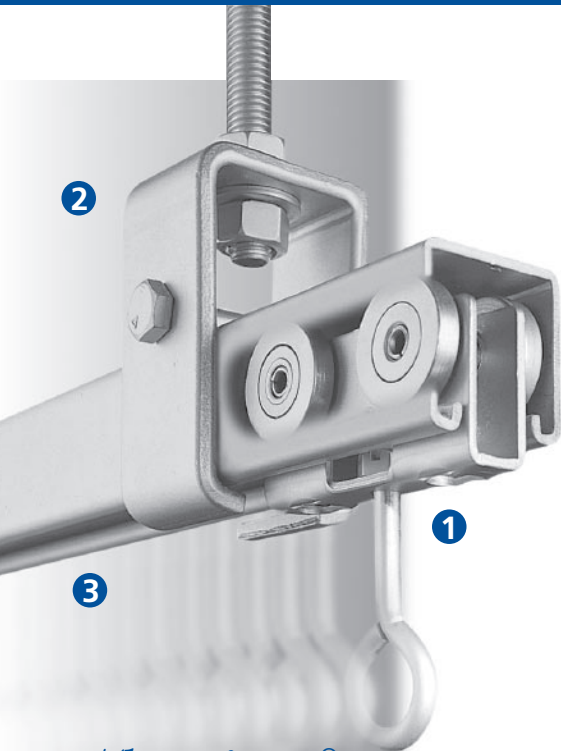

The Unistrut[®] trolley system offers important advantages over other systems, including greater efficiency, better economy and easier installation

1 TROLLEYS

Stainless-steel wheel bearings and steel or acetyl wheels require no lubrication, providing smooth, maintenance-free operation and long life.

2 SPECIAL SUPPORT FITTINGS

... provide strong support while keeping track interior obstruction-free.

3 CHANNEL TRACK

Inturned edges form strong, low-friction bearing surfaces.

An efficient system that keeps your jobs moving

The Unistrut trolley system moves equipment from 10 to 600 lbs., with reliability, ease and economy. Trolleys can be ganged to accommodate higher loads. Unistrut trolleys, featuring corrosion-free stainless wheel bearings and steel or acetyl wheels that require no lubrication, deliver built-in value and dependability for a wide range of applications. Throughout the system, famous Unistrut quality assures dependable, trouble-free performance.

Simple, versatile, and easy to install

Composed of three basic elements—trolleys, track and supports—Unistrut trolley systems are efficient and economical. Five different trolleys give users a wide range of weight capacities and suspension options, to allow tailoring of the system to exact application needs.

Track is available in 20-foot sections and can be easily field cut according to project requirements. Longer lengths and curved sections are available on special order. A complete system of easy-to-use supports, including beam clamps, make installation a breeze.

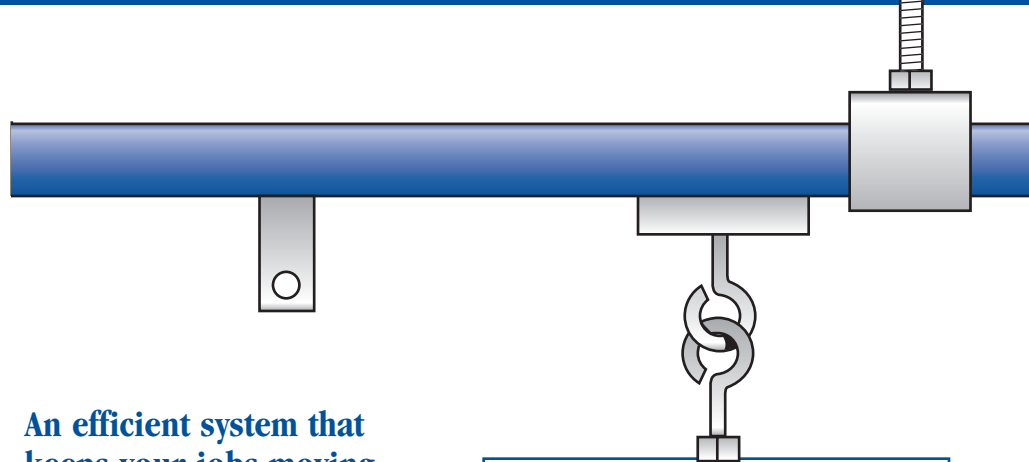

IDEAL FOR:

- *Pneumatic Tools*
- *Lubrication Systems*
- *Moveable Dividers*
- *Rolling Doors*
- *Die Handling*
- *Welding Curtains*
- *Material Transfer*

For detailed load data and related technical detail, see the Unistrut General Engineering Catalog No. 14.

... Proven in thousands of applications throughout North America and worldwide.

Available with curved track

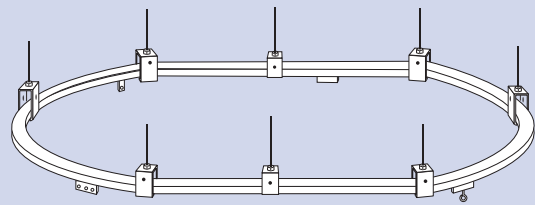

TROLLEYS

Engineered to accommodate a wide variety of tools, doors, curtains and fixtures.

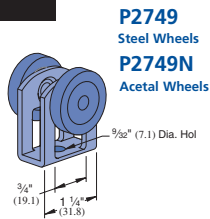

10-50 lb. design load

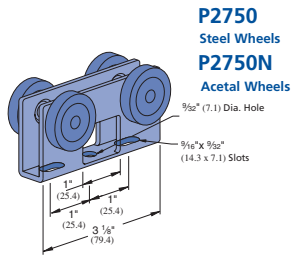
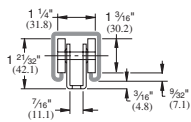

20-100 lb. design load

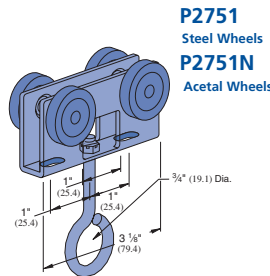
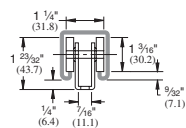

20-100 lb. design load

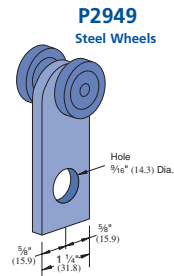
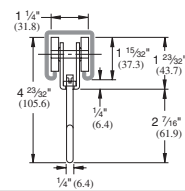

150-437 lb. design load

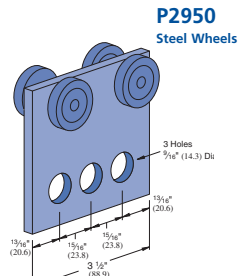
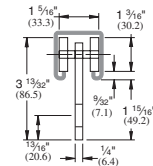

300-600 lb. design load

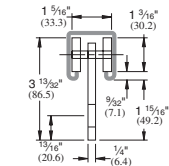

Curtain Slider

P5349

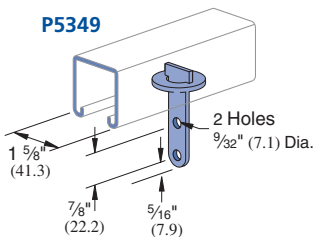

Design Load
20 Lbs (.1 kN)

TRACK

Unistrut 1-5/8" channel, famous for quality, reliability and ease of use.

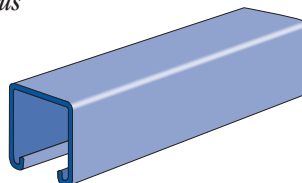

P1000

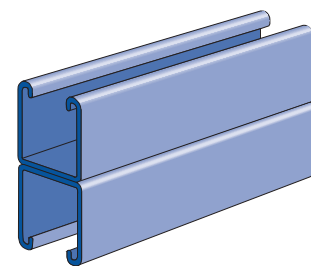
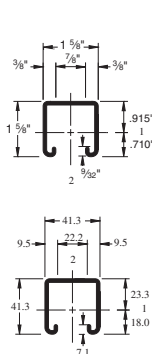

P1001

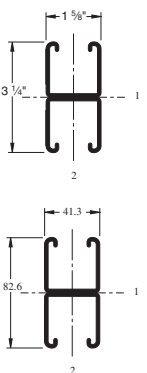
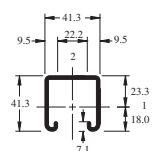

SUPPORT COMPONENTS

Specifically designed for Unistrut channel track.

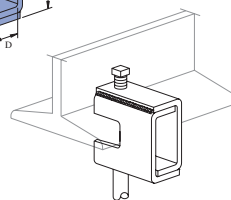
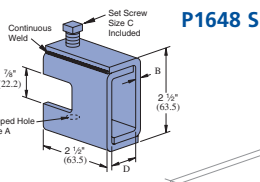
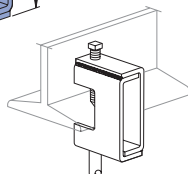
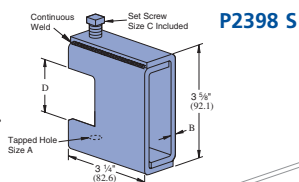

Beam Clamps

Channel Track Supports

P1834

Intermediate Hanger

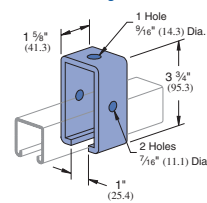

Design Load
1200 Lbs (5.3 kN)

P1834 A

Joiner/Hanger

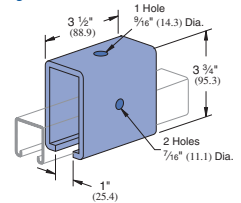

Design Load
2500 Lbs (11.1 kN)